

LogiCORE™ IP Initiator/Target v5.166 for PCI-X™

Getting Started Guide

UG158 April 24, 2009





Xilinx is providing this product documentation, hereinafter “Information,” to you “AS IS” with no warranty of any kind, express or implied. Xilinx makes no representation that the Information, or any particular implementation thereof, is free from any claims of infringement. You are responsible for obtaining any rights you may require for any implementation based on the Information. All specifications are subject to change without notice. XILINX EXPRESSLY DISCLAIMS ANY WARRANTY WHATSOEVER WITH RESPECT TO THE ADEQUACY OF THE INFORMATION OR ANY IMPLEMENTATION BASED THEREON, INCLUDING BUT NOT LIMITED TO ANY WARRANTIES OR REPRESENTATIONS THAT THIS IMPLEMENTATION IS FREE FROM CLAIMS OF INFRINGEMENT AND ANY IMPLIED WARRANTIES OF MERCHANTABILITY OR FITNESS FOR A PARTICULAR PURPOSE. Except as stated herein, none of the Information may be copied, reproduced, distributed, republished, downloaded, displayed, posted, or transmitted in any form or by any means including, but not limited to, electronic, mechanical, photocopying, recording, or otherwise, without the prior written consent of Xilinx.

The Design is not designed or intended for use in the development of on-line control equipment in hazardous environments requiring fail-safe controls, such as in the operation of nuclear facilities, aircraft navigation or communications systems, air traffic control, life support, or weapons systems (“High-Risk Applications”). Xilinx specifically disclaims any express or implied warranties of fitness for such High-Risk Applications. You represent that use of the Design in such High-Risk Applications is fully at your risk.

© 2000-2009 Xilinx, Inc. XILINX, the Xilinx logo, Virtex, Spartan, ISE and other designated brands included herein are trademarks of Xilinx in the United States and other countries. All other trademarks are the property of their respective owners.

Revision History

The following table shows the revision history for this document.

	Version	Revision
06/01/00	1.0	Initial Xilinx release.
11/11/04	3.5.2	Added installation and licensing chapter; updated to current template.
12/1/04	3.6	Virtex-4 updates; addition of information to Family Specific Considerations, Chapter 3.
3/7/05	3.7	Updated to system 7.1i and build 5.0.95
5/13/05	4.0	Updated to build 5.0.100 and Xilinx tools 7.1i SP2.
8/31/05	5.0	Updated to build 5.0.101 and Xilinx tools 7.1i SP3.
9/12/05	6.0	Updated to build 5.0.102, Xilinx tools 7.1i to SP4, changed release date, removed instruction to confirm directory structure from Core Licensing chapter.
1/18/06	7.0	Updated build to 5.0.105, Xilinx tools to 8.1i, release date, licensing chapter.
2/14/06	7.5	Advanced build to 108, added SP2 support to ISE v8.1i, updated release date.
7/13/06	8.0	Advanced build to 160, ISE to v8.21, release date
2/15/07	8.1	Advanced build to 161, release date, minor updates
5/17/07	9.0	Changed title and text references to PCI-X and PCI to comply with PCI-SIG trademark guidelines. Advanced build to 162, support for IUS to v5.7.
8/08/07	9.1	Updated for IP1 Jade Minor release. Changed capacitor value to 10 uF to match XAPP653 recommendation.
10/10/07	9.5	Updated for IP2 Jade Minor release. Added section regarding configuration pins to device family chapter.
3/24/08	10.0	Updated tools for IP0K release.
9/19/08	10.1	Updated to support ISE v10.1 Service Pack 3.
4/24/09	10.5	Updated to support ISE v11.1 and removed support for deprecated devices: Virtex-II, Virtex-II Pro, and Virtex-E.

Table of Contents

Schedule of Figures	7
Preface: About This Guide	
Guide Contents	9
Conventions	10
Typographical.....	10
Online Document.....	11
Chapter 1: Getting Started	
System Requirements	13
About the Example Design	13
Additional Documentation	14
Technical Support	14
Feedback	14
Core Interface for PCI-X.....	14
Document.....	14
Chapter 2: Licensing the Core	
Before you Begin	15
License Options	15
Full System Hardware Evaluation.....	15
Full.....	15
Obtaining Your License Key	16
Full System Hardware Evaluation License.....	16
Full License.....	16
Installing Your License File	16
Chapter 3: Family Specific Considerations	
Design Support	17
Wrapper Files.....	18
Constraints Files.....	18
Unsupported Devices.....	18
Device Initialization	19
Configuration Pins	19
Bus Width Detection	19
Bus Mode Detection	19
Bus Clock Usage	20
Electrical Compliance	20
Input Delay Buffers	21
Generating Bitstreams	22
Chapter 4: Functional Simulation	
Cadence IUS	25
Mentor Graphics ModelSim	26
Verilog.....	26

VHDL.....	27
-----------	----

Chapter 5: Synthesizing a Design

Synplicity Synplify.....	29
Verilog.....	29
VHDL.....	34
Exemplar LeonardoSpectrum	38
Xilinx XST	39

Chapter 6: Implementing a Design

ISE Foundation.....	41
----------------------------	-----------

Chapter 7: Timing Simulation

Cadence IUS.....	43
Mentor Graphics ModelSim.....	44
Verilog.....	44
VHDL.....	44

Schedule of Figures

Chapter 1: Getting Started

Chapter 2: Licensing the Core

Chapter 3: Family Specific Considerations

<i>Figure 3-1: PCI/PCI-X Output Driver VCCO Generation</i>	21
--	----

Chapter 4: Functional Simulation

Chapter 5: Synthesizing a Design

<i>Figure 5-1: Create a New Project</i>	29
<i>Figure 5-2: Main Project Window</i>	30
<i>Figure 5-3: Files to Add (Virtex Library)</i>	31
<i>Figure 5-4: Files to Add (LogiCORE Files)</i>	31
<i>Figure 5-5: Files to Add (User Application)</i>	32
<i>Figure 5-6: Source Files in Main Project Window</i>	32
<i>Figure 5-7: Options for Implementation: Device</i>	33
<i>Figure 5-8: Options for Implementation: Options/Constraints</i>	33
<i>Figure 5-9: Create a New Project</i>	34
<i>Figure 5-10: Main Project Window</i>	35
<i>Figure 5-11: Files to Add (Virtex Library)</i>	35
<i>Figure 5-12: Files to Add (LogiCORE Files)</i>	36
<i>Figure 5-13: Files to Add (User Application)</i>	36
<i>Figure 5-14: Main Project Window</i>	37
<i>Figure 5-15: Options for Implementation: Device</i>	38

Chapter 6: Implementing a Design

Chapter 7: Timing Simulation

About This Guide

The *Initiator/Target v5.166 for PCI-X Getting Started Guide* provides information about the LogiCORE™ IP interface core for Peripheral Component Interconnect Extended (PCI-X), which provides a fully verified, pre-implemented PCI-X bus interface targeting devices based on the Virtex® FPGA architecture.

The guide also includes an example design in both Verilog-HDL and VHDL that lets you simulate, synthesize, and implement the interface to understand the design flow for PCI-X.

Guide Contents

This manual contains the following chapters:

- [Chapter 1, “Getting Started,”](#) describes the Initiator/Target core for PCI-X and provides information about getting technical support, and providing feedback to Xilinx about the core and the accompanying documentation.
- [Chapter 2, “Licensing the Core,”](#) provides instructions for installing and obtaining a license for the core interface, which you must do before using it in your designs.
- [Chapter 3, “Family Specific Considerations,”](#) discusses design considerations specific to the core interface targeting Virtex devices.
- [Chapter 4, “Functional Simulation,”](#) describes the use of supported functional simulation tools, including Cadence® IUS and Mentor Graphics® ModelSim®.
- [Chapter 5, “Synthesizing a Design,”](#) describes the use of supported synthesis tools, including Synplicity Synplify, Exemplar LeonardoSpectrum, and Xilinx XST.
- [Chapter 6, “Implementing a Design,”](#) describes the use of supported FPGA implementation tools, included with the Xilinx ISE™ Foundation v11.1 software.
- [Chapter 7, “Timing Simulation,”](#) describes the use of supported post-route timing simulation tools, including Cadence IUS and Mentor Graphics ModelSim.

Conventions

Typographical

The following typographical conventions are used in this document:

Convention	Meaning or Use	Example
Courier font	Messages, prompts, and program files that the system displays	speed grade: - 100
Courier bold	Literal commands you enter in a syntactical statement	ngdbuild design_name
angle brackets < >	Variables in a syntax statement for which you must supply values	<design_name>
<i>Italic font</i>	References to other manuals	See the <i>Initiator/Target User Guide</i> for more information.
	Emphasis in text	If a wire is drawn so that it overlaps the pin of a symbol, the two nets are <i>not</i> connected.
Square brackets []	An optional entry or parameter. However, in bus specifications, such as bus [7 : 0] , they are required.	ngdbuild [option_name] design_name
Braces { }	A list of items from which you must choose one or more	lowpwr = {on off}
Vertical bar	Separates items in a list of choices	lowpwr = {on off}
Vertical ellipsis . . .	Repetitive material that has been omitted	IOB #1: Name = QOUT' IOB #2: Name = CLKIN' . . .
Horizontal ellipsis ...	Omitted repetitive material	allow block block_name loc1 loc2... locn;

Online Document

The following conventions are used in this document:

Convention	Meaning or Use	Example
Blue text	Cross-reference link to a location in the current document	See “ Additional Resources ” for details. See “ Title Formats ” in Chapter 1 for details.
Blue, underlined text	Hyperlink to a website (URL)	Go to http://www.xilinx.com for the latest speed files.

Getting Started

The Initiator/Target core for PCI-X provides a fully verified, pre-implemented PCI-X bus interface targeted for devices based on the Virtex architecture. This chapter provides information about the example design, resources for additional documentation, obtaining technical support, and providing feedback to Xilinx about the core and its documentation.

System Requirements

Windows

- Windows XP® Professional 32-bit/64-bit
- Windows Vista® Business 32-bit/64-bit

Solaris/Linux

- Red Hat® Enterprise Linux WS v4.0 32-bit/64-bit
- Red Hat® Enterprise Desktop v5.0 32-bit/64-bit (with Workstation Option)
- SUSE Linux Enterprise (SLE) v10.1 32-bit/64-bit

Software

- ISE™ software v11.1

Check the release notes for the required service pack; ISE software service packs can be downloaded from www.xilinx.com/support/download/index.htm.

About the Example Design

The example design is a simple user application. It is provided as a training tool and design flow test. The example design consists of the user application *Userapp*, and supporting files for simulation and implementation.

The *Userapp* example design includes a test bench capable of generating simple read and write transactions. This stimulation generation capability is used to set up the configuration space of the design, and then perform some simple transactions. In addition, a special configuration file is provided with the *Userapp* design, and the test bench makes assumptions about the size and number of base address registers used.

You can change the core options related to implementation—options that relate to the selected FPGA architecture. However, do not change core options that alter the functional behavior of the core; such change may cause unpredictable results when you simulate the example design. For custom designs, you have the flexibility to change the core configuration as described in the *Initiator/Target v5.166 for PCI-X User Guide*.

Step-by-step instructions using supported design tools are provided in this guide to simulate, synthesize, and implement the *Userapp* example design.

Additional Documentation

For more information about the core interface, see the following documents, provided in the CORE Generator zip file:

- *Initiator/Target for PCI-X User Guide*
- *Initiator/Target Release Notes*

Further information is available in the [Mindshare PCI System Architecture](#) text, and the PCI Local Bus Specification, available from the [PCI Special Interest Group](#) site.

Technical Support

For technical support, visit www.xilinx.com/support. Questions are routed to a team of engineers with expertise using the Initiator/Target core for PCI-X.

Xilinx provides technical support for use of this product as described in the User and Getting Started Guides for this core. Xilinx cannot guarantee timing, functionality, or support of this product for designs outside of these guidelines.

Feedback

Xilinx welcomes comments and suggestions about the core interface for PCI-X and the documentation supplied with the core.

Core Interface for PCI-X

For comments or suggestions about the core interface for PCI-X, please submit a WebCase from www.xilinx.com/support/clearexpress/websupport.html. Be sure to include the following information:

- Product name
- Core version number
- Explanation of your comments

Document

For comments or suggestions about this document, please submit a WebCase from www.xilinx.com/support/clearexpress/websupport.htm. Be sure to include the following information:

- Document title and number
- Page number(s) to which your comments refer
- Explanation of your comments

Licensing the Core

This chapter provides instructions for installing and obtaining a license for the Initiator/Target core for PCI-X, which you must do before using it in your designs. The core is provided under the terms of the [Xilinx LogiCORE Site License Agreement](#), which conforms to the terms of the [SignOnce](#) IP License standard defined by the Common License Consortium. Purchase of the core entitles you to technical support and access to updates for a period of one year.

Before you Begin

This chapter assumes you have installed the core using either the CORE Generator™ IP Software Update installer or by performing a manual installation after downloading the core from the web.

License Options

The Initiator/Target core for PCI-X provides two licensing options. After installing the required Xilinx ISE software and IP Service Packs, choose a license option.

Full System Hardware Evaluation

The Full System Hardware Evaluation license is available at no cost and lets you fully integrate the core into an FPGA design, place-and-route the design, evaluate timing, and perform functional simulation of the Initiator/Target core for PCI-X using the example design and demonstration test bench provided with the core.

In addition, the license key lets you generate a bitstream from the placed and routed design, which can then be downloaded to a supported device and tested in hardware. The core can be tested in the target device for a limited time before timing out (ceasing to function), at which time it can be reactivated by reconfiguring the device.

Full

The Full license key is available when you purchase the core and provides full access to all core functionality both in simulation and in hardware, including:

- Functional simulation support
- Full implementation support including place and route and bitstream generation
- Full functionality in the programmed device with no time outs

Obtaining Your License Key

This section contains information about obtaining a simulation, full system hardware, and full license keys.

Full System Hardware Evaluation License

To obtain a Full System Hardware Evaluation license, do the following:

1. Navigate to the product page for this core: www.xilinx.com/pci
2. Click **Evaluate** and follow the instructions to generate the license key.

Full License

To obtain a Full license key, you must purchase a license for the core. After doing so, click the "Access Core" link on the Xilinx.com IP core product page for further instructions.

Installing Your License File

For the Full System Hardware Evaluation license and the Full license, an email will be sent to you containing instructions for installing your license file. Additional details about IP license key installation can be found in the ISE Design Suite Installation, Licensing and Release Notes document.

Family Specific Considerations

This chapter provides important design information specific to the core interface targeting Virtex devices.

Design Support

Table 3-1 provides a list of supported device and interface combinations, consisting of a device, a bus interface type, and two or three specific implementation files.

Table 3-1: Device and Interface Selection

Supported Device	Bus Type	Wrapper File Simulation Model	Constraints File
Virtex-4 Devices			
4VFX20-FF672-10C/I	33 MHz PCI 3.3V 64-bit	pcix_lc_64.ng pcix_core	4vfx20ff672_64ng.ucf
4VFX20-FF672-10C/I	66 MHz PCI-X 3.3V 64-bit	pcix_lc_64x pcix_core	4vfx20ff672_64x.ucf
4VFX20-FF672-10C/I	100 MHz PCI-X 3.3V 64-bit	pcix_lc_64x pcix_core	4vfx20ff672_64xf.ucf
4VFX20-FF672-10C/I	133 MHz PCI-X 3.3V 64-bit	pcix_lc_64x pcix_core	4vfx20ff672_64xf.ucf
4VLX25-FF668-10C/I	33 MHz PCI 3.3V 64-bit	pcix_lc_64.ng pcix_core	4vix25ff668_64ng.ucf
4VLX25-FF668-10C/I	66 MHz PCI-X 3.3V 64-bit	pcix_lc_64x pcix_core	4vix25ff668_64x.ucf
4VLX25-FF668-10C/I	100 MHz PCI-X 3.3V 64-bit	pcix_lc_64x pcix_core	4vix25ff668_64xf.ucf
4VLX25-FF668-10C/I	133 MHz PCI-X 3.3V 64-bit	pcix_lc_64x pcix_core	4vix25ff668_64xf.ucf
4VSX35-FF668-10C/I	33 MHz PCI 3.3V 64-bit	pcix_lc_64.ng pcix_core	4vsx35ff668_64ng.ucf

Table 3-1: Device and Interface Selection

Supported Device	Bus Type	Wrapper File Simulation Model	Constraints File
4VSX35-FF668-10C/I	66 MHz PCI-X 3.3V 64-bit	pcix_lc_64x pcix_core	4vsx35ff668_64x.ucf
4VSX35-FF668-10C/I	100 MHz PCI-X 3.3V 64-bit	pcix_lc_64x pcix_core	4vsx35ff668_64xf.ucf
4VSX35-FF668-10C/I	133 MHz PCI-X 3.3V 64-bit	pcix_lc_64x pcix_core	4vsx35ff668_64xf.ucf

Wrapper Files

Wrapper files contain an instance of the core interface and its simulation model, as well as the instances of all I/O elements used by the core interface. Each wrapper file is specific to a particular implementation.

The wrapper files, located in the `<Install Path>/hdl/src/wrap` directory, are actually variations of the `pcix_lc.hdl` file located in the `<Install Path>/hdl/src/xpci` directory. The file in the `<Install Path>/hdl/src/xpci` is suitable for functional simulation in most modes. When starting a new design, copy the appropriate wrapper file from the `wrap/` directory into the `xpci/` directory, and rename it as `pcix_lc.hdl`.

The simulation models, located in the `<Install Path>/hdl/src/xpci` directory, contain structural simulation models of the interface. Note that there are multiple simulation models as there are multiple interface netlists. Each wrapper file instantiates a specific simulation model.

Constraints Files

The constraints files contain various constraints required for the core interface, and must always be used while processing a design. Each constraints file is specific to a particular device and interface—use the appropriate constraints file from the `<Install Path>/hdl/src/ucf` directory when processing designs using the Xilinx implementation tools.

Note: The example design relies on the presence of the default `pcix_lc.hdl` wrapper file in the `xpci/` directory. If you change this file, you must also change the constraints files used in the processing scripts.

Unsupported Devices

If you wish to target a device/package combination that is not officially supported (not listed in the *Initiator/Target for PCI-X Data Sheet*), you may use the UCF Generator for PCI/PCI-X to create a user constraints file that implements a suitable pinout for your target device. For Virtex-4 devices, this tool is available in the Xilinx CORE Generator under **UCF Generator for PCI/PCI-X**. For more information on this tool, consult the *UCF Generator for PCI/PCI-X Data Sheet*.

Note: It is important to verify the UCF files generated by this tool to confirm that the timing requirements of your application are met. Xilinx cannot guarantee that every UCF file generated by the UCF Generator tool will work for every application.

Device Initialization

Immediately after FPGA configuration, both the core interface and the user application are initialized by the startup mechanism present in all Virtex devices. During normal operation, the assertion of `RST#` on the PCI-X bus reinitializes the core interface and three-state all PCI-X bus signals. This behavior is fully compliant with the *PCI Local Bus Specification*. The core interface is designed to correctly handle asynchronous resets.

Typically, the user application must be initialized each time the core interface is initialized. In this case, use the `RST` output of the core interface as the asynchronous reset signal for the user application. If part of the user application requires an initialization capability that is asynchronous to PCI-X bus resets, simply design the user application with a separate reset signal.

Note that these reset schemes require the use of routing resources to distribute reset signals, since the global resource is not used. The use of the global reset resource is not recommended.

Configuration Pins

Designers should be aware that PCI-X bus interface pins should not be placed on the dual purpose I/O pins used for configuration. Please verify the selected UCF to ensure that the pins do not conflict with the pins used for the chosen configuration mode. It is fine for PCI-X pins to be located on dual purpose I/O configuration pins that are NOT also used for configuration. Please refer to the appropriate device pin-out guide for locations of configuration pins.

Bus Width Detection

A core interface that provides a 64-bit datapath needs to know if it is connected to a 64-bit bus or a 32-bit bus. The core interface is capable of sensing and adjusting to the bus width automatically. However, this behavior can be manually forced by setting options in the HDL configuration file. For more information, see the *Initiator/Target for PCI-X User Guide*, and the following section about bus mode detection.

Bus Mode Detection

A core interface that provides backward compatibility with PCI mode must determine whether it is in PCI-X bus mode or PCI bus mode. The core interface is capable of sensing and adjusting to the bus mode automatically. However, this behavior can be manually forced by setting options in the HDL configuration file. See the *Initiator/Target for PCI-X User Guide* for details.

For designs that use multiple bitstreams, the `RTR` output of the core interface will assert following the deassertion of the bus reset signal if the interface recognizes that the incorrect bitstream is in use. When this occurs, external circuitry is responsible for re-initializing the FPGA and loading an alternate bitstream. This requires storage for two complete bitstreams and another device, such as a CPLD, for managing the reconfiguration process.

The reconfiguration process cannot be controlled by the FPGA because the FPGA becomes inactive during configuration.

The bitstream loaded in response to **RTR** will become active after the bus reset and the design will not be present to observe the busmode and buswidth broadcast. Missing the busmode broadcast is not an issue, as the newly loaded bitstream will be correct for the busmode in use. However, the newly loaded bitstream will not know if the bus is 32-bit or 64-bit. Upon the assertion of **RTR**, the FPGA must save the buswidth state in the CPLD so that the CPLD can restore it later.

Bus width is visible on the **PCIW_EN** signal when the Buswidth Detect Disable option is set to false in the **CFG** module, even if previously set to true. Buswidth may be forced by setting this option to true and then setting Bus Width Manual As 32-bit appropriately. While single bitstream designs will set these **CFG** options to permanent true or false values, it is possible to control these options dynamically by adding ports to the **CFG** module and making signal assignments to **CFG[502]** and **CFG[503]**. This important concern is a board level design requirement and the exact implementation is dependent on the specific configuration method used. For more information about saving these values and designing a mechanism to reconfigure the FPGA, see [XAPP 938](#).

[Table 3-2](#) describes available implementation options. For system interface implementations that with 1 or 2 bitstreams, the 2-bitstream implementation is allowed to provide for future enhancement to a faster bus interface.

Table 3-2: Bitstream Requirements

Desired System Interface Implementation	Bitstreams
Virtex-4 Devices, PCI Only 33 MHz	1
Virtex-4 Devices, PCI-X Only 66/100/133 MHz	1
Virtex-4 Devices, PCI-X 100 MHz with PCI 33 MHz	2
Virtex-4 Devices, PCI-X 133 MHz with PCI 33 MHz	2
Virtex-4 Devices, PCI-X 66 MHz with PCI 33 MHz	2

Bus Clock Usage

The bus clock output provided by the interface is derived from the bus clock input, and is distributed using a global clock buffer. The interface itself is fully synchronous to this clock. In general, the portion of the user application that communicates with the interface must also be synchronous to this clock.

It is important to note that the frequency of this clock is not guaranteed to be constant. In fact, in a compliant system, the clock may be any frequency, up to and including the maximum allowed frequency, and the frequency may change on a cycle-by-cycle basis. Under certain conditions, the PCI-X core may also apply phase shifts to this clock.

For these reasons, the user application should not use this clock as an input to a DLL or PLL, nor should the user application use this clock in the design of interval timers (for example, DRAM refresh counters).

Electrical Compliance

Virtex-4 devices, as specified in the device data sheet, exhibit a 10 pF pin capacitance. This is compliant with the *PCI Local Bus Specification*, with one exception. The specification

requires an 8 pF pin capacitance for the IDSEL pin, to allow for non-resistive coupling to an AD[xx] pin. In practice, this coupling may be resistive or non-resistive, and is performed on the system board or backplane. For system board or backplane designs, use resistive coupling to avoid non-compliance. For add-in cards, this is not under the control of the designer.

The *PCI-X Addendum* requires an 8 pF pin capacitance for all pins. Virtex-4 devices do not comply with this requirement.

Although the core interface provides a direct PME# output from a general purpose I/O pin, this output signal has certain limitations. If the FPGA power is removed, the general purpose I/O pin will appear as a low impedance to ground. This appears to the system as an assertion of PME#. For this reason, implementations that use the PME# signal should employ an external buffering scheme that will prevent false assertions of PME# when power is removed from the FPGA device.

For 3.3 volt signaling in Virtex-4 devices, the V_{CCO} supply must be reduced to 3.0 volts and derived from a precision regulator. This reduction of the output driver supply provides robust device protection without sacrificing PCI electrical compliance, even in the extreme case where the 3.3 volt system supply climbs as high as 3.6 volts, as allowed by the *PCI Local Bus Specification*.

Figure 3-1 illustrates one possible low-cost solution to generate the required 3.0 volt output driver supply. Xilinx recommends the use of this circuit; however, other approaches using other regulators are possible.

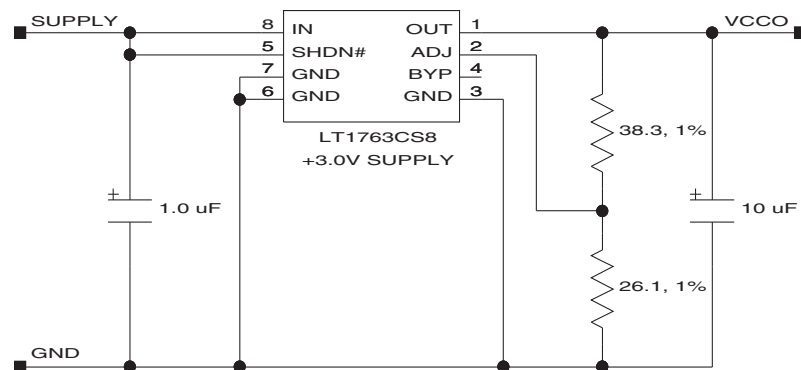

Figure 3-1: PCI/PCI-X Output Driver VCCO Generation

Input Delay Buffers

Input delay buffers are used to provide guaranteed hold time on all bus inputs when in PCI bus mode. Where possible, the core interface targeting Virtex devices uses input delay elements present in the IOBs of the FPGA device. The use of these delay buffers is selected through the implementation specific constraints file.

Virtex-4 FPGA implementations that support PCI bus mode make use of the new IDELAY input delay buffer primitives. An IDELAY input delay buffer is a calibrated and adjustable delay line. This delay mechanism provides superior performance over the legacy input delay buffers.

Designs that use IDELAY primitives also require the use of the IDELAYCTRL primitive. The function of the IDELAYCTRL primitive is to calibrate the IDELAY delay lines. To perform this calibration, the IDELAYCTRL primitive requires a 200 MHz input clock. The design and wrapper files for use with reference clocks contain IDELAY instances,

IDELAYCTRL instances, and an additional input, REF_I, for a 200 MHz reference clock from an I/O pin. This reference clock is distributed to all applicable IDELAYCTRL primitives using a global clock buffer. It is important to note that there is some flexibility in the origin, generation, and use of this 200 MHz reference clock. The provided design and wrapper files represent a trivial case that can may be modified to suit specific design requirements.

- For designs requiring IDELAY and IDELAYCTRL for other IP cores, or custom user logic, the 200 MHz reference clock can be shared. It is possible to tap the reference clock in the wrapper file, after it is driven by the global buffer. This signal may be used by other IDELAY and IDELAYCTRL instances.
- For designs that already have a 200 MHz reference clock distributed on a global clock buffer, this clock can be shared. The wrapper file can be modified to remove the external I/O pin and the global clock buffer instance. Simply tap the existing 200 MHz clock signal and bring it into the wrapper file for the interface to use.
- For designs that do not have a 200 MHz reference clock, it may be possible to generate a 200 MHz reference clock using a Digital Clock Manager (DCM) and another clock. The other clock may be available internally or externally, but must be fixed frequency. In this case, it is the responsibility of the user to verify the following:
 1. The jitter of the source clock, to determine if it is appropriate for use as an input to a DCM.
 2. The DCM configuration, to generate a 200 MHz clock on any appropriate DCM output (CLKFX, CLKDV, and so forth).
 3. The jitter of the derived 200 MHz reference clock, to determine if it is appropriate for use as an input to an IDELAYCTRL.
 4. The IDELAYCTRL reset must be tied to the DCM lock output so that the IDELAYCTRL remains in reset until the DCM is locked.

For more information about timing parameters, see the [Virtex-4 FPGA Data Sheet](#) and [Virtex-4 FPGA User Guide](#). As with the other implementation options, the derived 200 MHz reference clock must be distributed by a global clock buffer to the IDELAYCTRL instances.

Warning! The fixed frequency requirement of the source clock precludes the use of the PCI bus clock, unless the design is used in an embedded/closed system where the PCI bus clock is known to be a fixed frequency. See “[Bus Clock Usage](#)” for additional information about the allowed behavior of the PCI bus clock in compliant systems.

Generating Bitstreams

The bitstream generation program, bitgen, may issue DRC warnings when generating bitstreams for PCI-X designs. The number of these warnings varies depending on the configuration options used for the PCI-X core. Typically, these warnings are related to nets with no loads generated during trimming by the map program. Some of these nets are intentionally preserved by statements in the user constraints file.

Please be aware that the bitgen options provided with the example design are only for reference. The actual options used will depend on the desired FPGA configuration method and clock rate of your complete design, as implemented on a board. Please carefully consider the following configuration time requirements when selecting a configuration method and clock rate.

1. Any designs that do not automatically sense both the bus width and bus mode must be configured within $(100 \text{ ms} + 2^{25} \text{ bus clocks})$ after the bus power rails become valid.

2. Any designs that must sense either the bus width or the bus mode must be configured within 100 ms after the bus power rails become valid.
3. Carbus designs must be configured as quickly as possible after the bus power rails become valid.

Functional Simulation

This chapter describes how to simulate the *Userapp* example design using the supported functional simulation tools. If you are using a design with reference clocks, substitute *pcix_top* with *pcix_top_r* and *test_tb* with *test_tb_r*.

Supported functional simulation tools include:

- Cadence IUS v8.1 -s009
- Mentor Graphics ModelSim v6.4b

Cadence IUS

Before attempting functional simulation, ensure that the IUS environment is properly configured.

1. Navigate to the functional simulation directory:

```
cd <Install Path>/verilog/example/func_sim
```

2. Edit the *test_tb.f* file. This file lists command line arguments for IUS, as shown below:

```
../source/global.v
../source/cfg_test_s.v
../source/stimulus.v
../source/test_tb.v
../source/busrec.v
../source/pcix_top.v
../source/userapp.v
../../../../src/xpci/pcix_lc.v
../../../../src/xpci/pcix_core.v
+libext+.vmd+.v
-y <Xilinx Install Path>/verilog/src/unisims
-y <Xilinx Install Path>/verilog/src/simprims
```

3. Modify the library search path by changing *<Xilinx Install Path>* to match the Xilinx installation directory. If you have changed the wrapper file, be sure you are using the correct simulation model.
4. Save the file.

Most of the files listed are related to the example design and its test bench. For other test benches, the following subset must be used for proper simulation of the core interface:

```
../source/global.v
```

```

../../src/xpci/pcix_lc.v
../../src/xpci/pcix_core.v
+libext+.vmd+.v
-y <Xilinx Install Path>/verilog/src/unisims
-y <Xilinx Install Path>/verilog/src/simprims

```

This subset list does not include any configuration file, user application, top-level wrapper, or test bench. These additional files are required for a meaningful simulation.

- To run the IUS simulation, type the following:

```
ncverilog -f test_tb.f
```

IUS processes the simulation files and exits. The test bench prints status messages to the console.

- After completing simulation, view the `ncverilog.log` file to check for errors.

The Simvision browser may be used to view the simulation results.

- If desired, start Simvision using the following command:

```
simvision
```

Mentor Graphics ModelSim

Before attempting functional simulation, ensure that the ModelSim environment is properly configured.

Verilog

- Navigate to the functional simulation directory:

```
cd <Install Path>/verilog/example/func_sim
```

- Edit the `test_tb.f` file. This file lists command line arguments, and is shown below:

```

./source/global.v
./source/cfg_test_s.v
./source/stimulus.v
./source/test_tb.v
./source/busrec.v
./source/pcix_top.v
./source/userapp.v
../../src/xpci/pcix_lc.v
../../src/xpci/pcix_core.v
+libext+.vmd+.v
-y <Xilinx Install Path>/verilog/src/unisims
-y <Xilinx Install Path>/verilog/src/simprims

```

- Modify the library search path by changing `<Xilinx Install Path>` to match the Xilinx installation directory. If you have changed the wrapper file make sure you are using the correct simulation model.
- Save the file.

Most of the files listed are related to the example design and its test bench. For other test benches, the following subset must be used for proper simulation of the core interface:

```
../source/glbl.v
../../src/xpci/pcix_lc.v
../../src/xpci/pcix_core.v
+libext+.vmd+.v
-y <Xilinx Install Path>/verilog/src/unisims
-y <Xilinx Install Path>/verilog/src/simprims
```

This list does not include any configuration file, user application, top level wrapper, or test bench. These additional files are required for a meaningful simulation.

5. Invoke ModelSim and ensure that the current directory is set to the following:

```
<Install Path>/verilog/example/func_sim
```

6. To run the simulation, type the following:

```
do modelsim.do
```

This compiles all modules, loads them into the simulator, displays the waveform viewer, and runs the simulation.

VHDL

1. Navigate to the functional simulation directory:

```
cd <Install Path>/vhdl/example/func_sim
```

2. View the test.files file. This file lists the individual source files required, and is shown below:

```
../../src/xpci/pcix_lc.vhd
../../src/xpci/pcix_core.vhd
../source/cfg_test_s.vhd
../source/userapp.vhd
../source/pcix_top.vhd
../source/busrec.vhd
../source/stimulus.vhd
../source/test_tb.vhd
```

If you have changed the wrapper file make sure you are using the correct simulation model. Most of the files listed are related to the example design and its test bench. For other test benches, the following subset must be used for proper simulation of the core interface:

```
../../src/xpci/pcix_lc.vhd
../../src/xpci/pcix_core.vhd
```

This subset list does not include any configuration file, user application, top level wrapper, or test bench. These additional files are required for a meaningful simulation.

3. Invoke ModelSim, and ensure that the current directory is set to the following:

```
<Install Path>/vhdl/example/func_sim
```

4. Create the SimPrim and UniSim libraries. This step only needs to be done once, the first time you perform a simulation:

```
vlib simprim
vcom -93 -work simprim <Xilinx Install
Path>/vhdl/src/simprims/simprim_Vpackage_mti.vhd
vcom -93 -work simprim <Xilinx Install
Path>/vhdl/src/simprims/simprim_Vcomponents_mti.vhd
vcom -93 -work simprim <Xilinx Install
Path>/vhdl/src/simprims/simprim_VITAL_mti.vhd
vlib unisim
vcom -93 -work unisim <Xilinx Install
Path>/vhdl/src/unisims/unisim_VPKG.vhd
vcom -93 -work unisim <Xilinx Install
Path>/vhdl/src/unisims/unisim_VCOMP.vhd
vcom -93 -work unisim <Xilinx Install
Path>/vhdl/src/unisims/unisim_VITAL.vhd
```

5. To run the simulation, type the following:

```
do modelsim.do
```

Synthesizing a Design

This chapter describes the use of supported synthesis tools using the *Userapp* example design for step-by-step instructions and illustrations. If you are using a design with reference clocks, substitute *pcix_top* with *pcix_top_r* and *test_tb* with *test_tb_r*.

Supported synthesis tools include

- Synplicity Synplify
- Exemplar LeonardoSpectrum
- Xilinx XST

Each section in this chapter illustrates how to synthesize the example design for dual-mode operation with a single bitstream. The synthesis flow for other configurations is identical.

Synplicity Synplify

Before synthesizing a design, ensure that the Synplicity Synplify environment is properly configured.

Verilog

1. Start Synplify and choose File > New (Figure 5-1), or click the new file icon on the tool bar.

The New dialog appears.

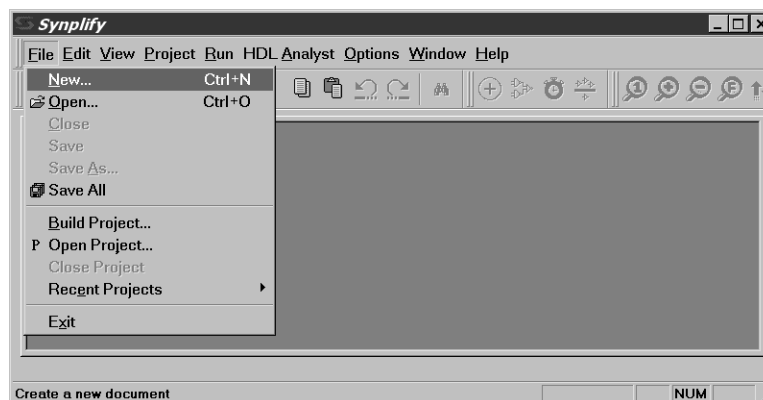

Figure 5-1: Create a New Project

- Under File Type, select Project File and enter the project name (*flowtest* in this example) and synthesis directory:
<Install Path>/verilog/example/synthesis
- Click OK to return to the project window (Figure 5-2).

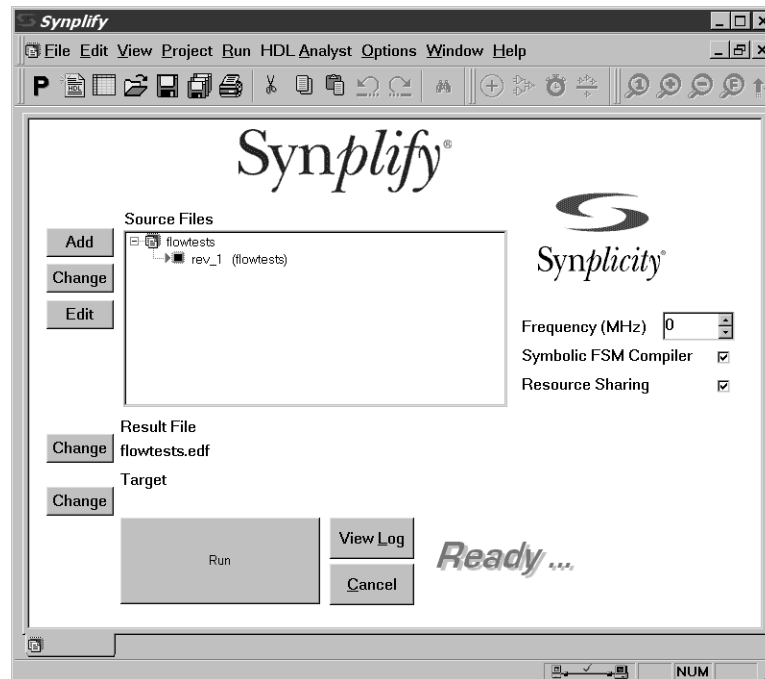

Figure 5-2: Main Project Window

- To add source files to the new project, click Add. The first file (used by any design that instantiates Xilinx primitives) is located in:
<Synplicity Install Path>/lib/xilinx

- Navigate to the virtex.v file (Figure 5-3); then click Add to move this source file into the Files To Add list.

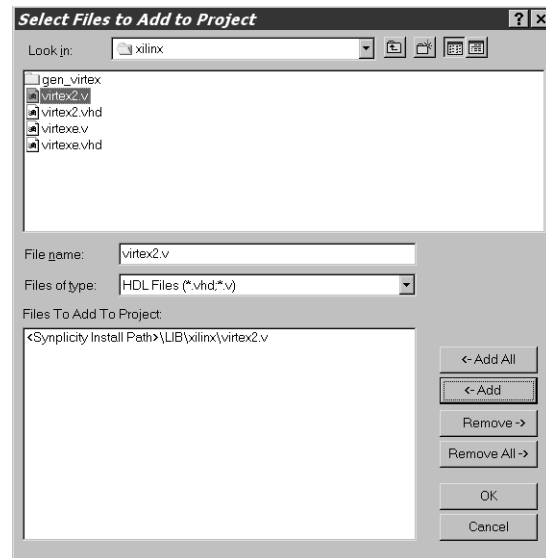

Figure 5-3: Files to Add (Virtex Library)

The next files are located in:

<Install Path>/verilog/src/xpci

- Navigate to the xpci directory (Figure 5-4), select the simulation model and the wrapper files (pcix_core.v and pcix_lc.v), and click Add to move these files into the Files To Add list. (Ctrl + click to select multiple files.)

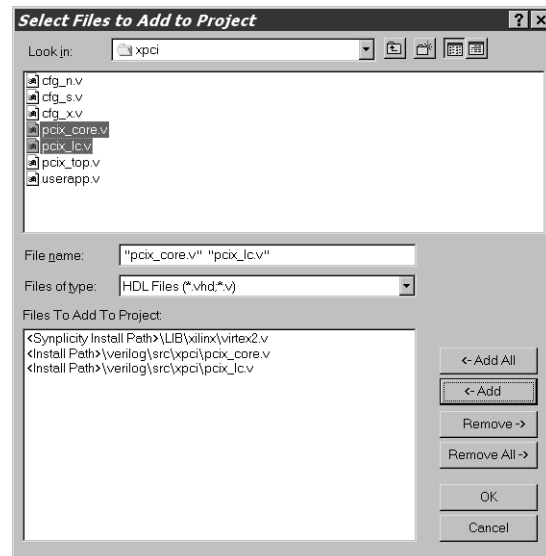

Figure 5-4: Files to Add (LogiCORE Files)

The final set of design files (the user application) is located in:

<Install Path>/verilog/example/source

7. Navigate to the source directory (Figure 5-5), select the `cfg_test_s.v`, `pcix_top.v`, and `userapp.v` files, and then click Add.

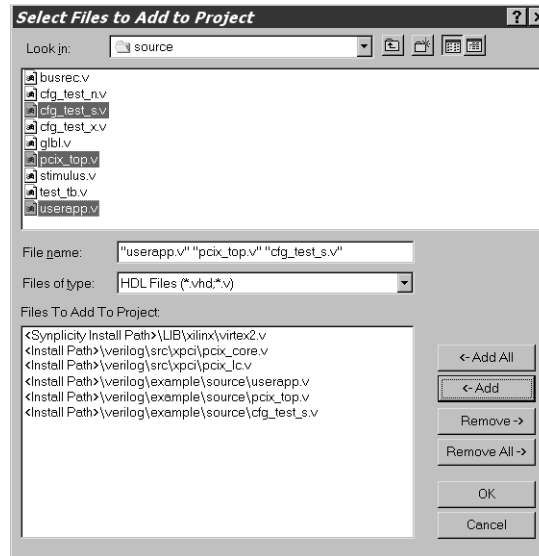

Figure 5-5: Files to Add (User Application)

8. After adding the three final files (for a total of six source files), click OK to return to the main project window.
9. In the Source Files list, view the list of newly added source files by double-clicking the `flowtests/verilog` folder (if it is not already open). Reorder the source files in the folder by dragging them to list them in the hierarchical order displayed in Figure 5-6.

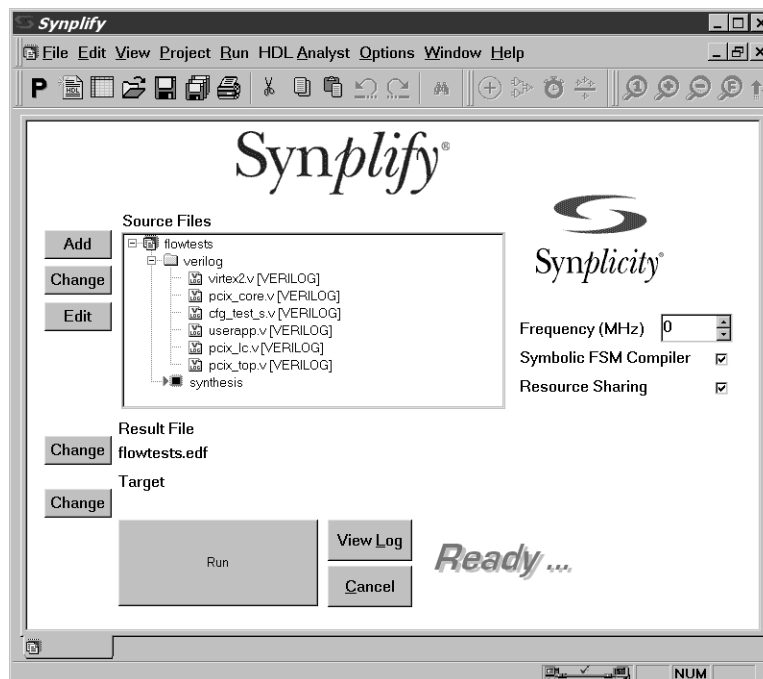

Figure 5-6: Source Files in Main Project Window

10. Click Change Result File to display the EDIF Result File dialog box; then move the to following directory:
`<Install Path>/verilog/example/synthesis`
11. Name the file `pcix_top_s.edif` and click OK to set the name of the result file and return to the main project window.
Note: In practice, the directory for the EDIF result file does not need to be changed. However, the sample processing scripts included with the example design assume that the output EDIF files will be located in the `synthesis` directory.
12. From the main project window, click Change Target to display the Options for Implementation dialog, [Figure 5-7](#).

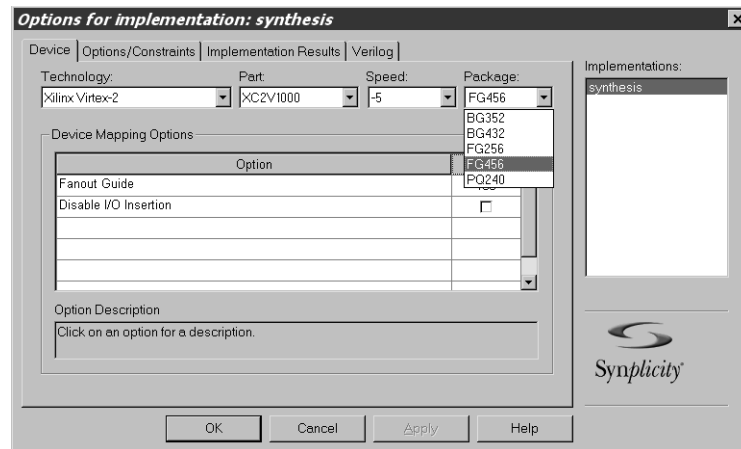

Figure 5-7: Options for Implementation: Device

13. On the Device tab, set the Technology, Part, Speed, and Package options to reflect the targeted device (a 2V1000FG456-5 in this example). Be sure that Disable I/O Insertion is deselected.
14. On the Options/Constraints tab, deselect Symbolic FSM Compiler (but leave Resource Sharing selected) and set the Frequency to 66 MHz.

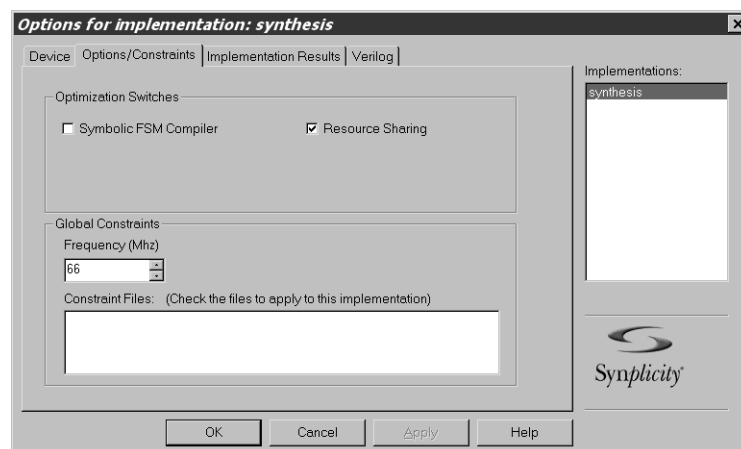

Figure 5-8: Options for Implementation: Options/Constraints

15. On the Implementation Results tab, deselect Write Vendor Constraint File.
16. Click OK to return to the main project window.
17. From the main project window, click Run.

Synplify synthesizes the design and writes out an optimized EDIF file. In the lower-right corner of the window, the various stages or synthesis, such as Compiling or Mapping, are displayed.

When the process is complete, *Done* is displayed. Synplify may issue a number of warnings (which are expected) about instantiated I/O cells and attributes used for other synthesis tools.

VHDL

1. Start Synplify and choose File > New (Figure 5-9), or use the new file icon on the tool bar. The New dialog appears.

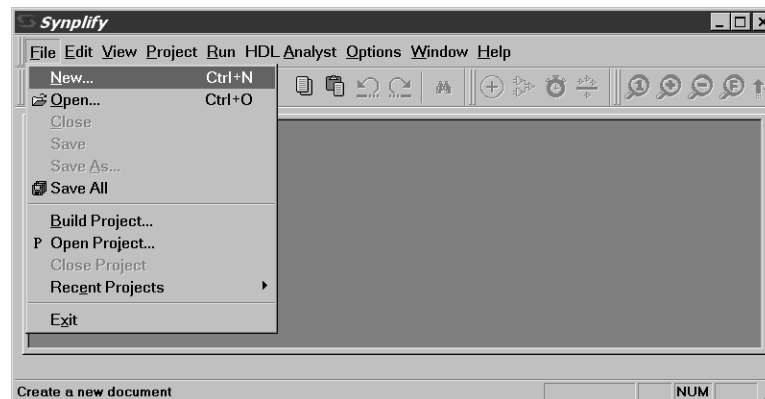

Figure 5-9: Create a New Project

2. Under File Type, select Project File and enter the project name (*flowtest* in this example) and synthesis directory:

```
<Install Path>/vhdl/example/synthesis
```

- Click OK to exit the dialog and return to the project window (Figure 5-10).

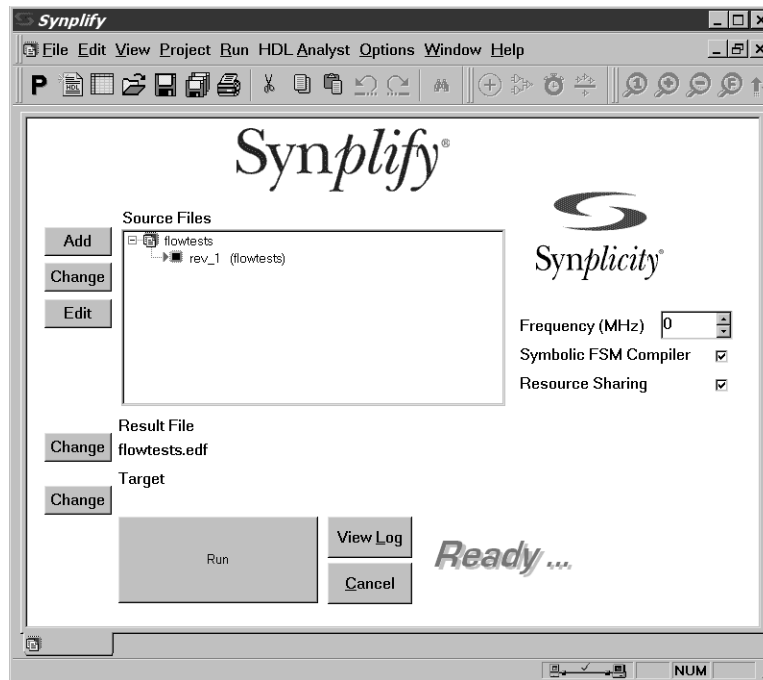

Figure 5-10: Main Project Window

- To add source files to the new project, click Add.
The first file (used by any design that instantiates Xilinx primitives) is located in:
<Synplicity Install Path>/lib/xilinx
- Select the `virtex.vhd` file (Figure 5-11); then click Add to move the file into the Files To Add list.

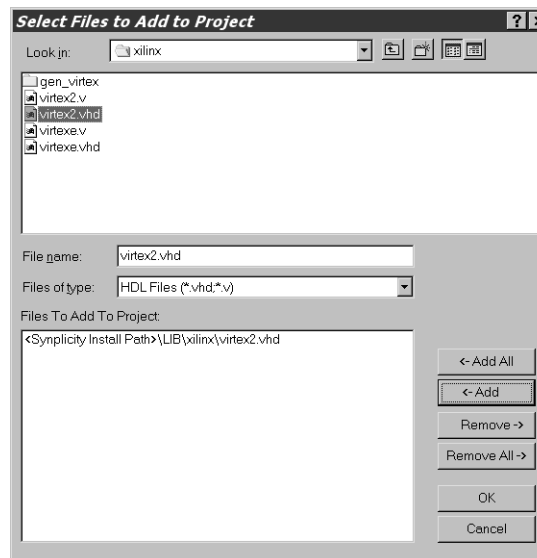

Figure 5-11: Files to Add (Virtex Library)

The next files are located in:

<Install Path>/vhdl/src/xpci

- Navigate to the xpci directory (Figure 5-12), select the simulation model and the wrapper files (pcix_core.vhd and pcix_lc.vhd), and click Add to move these files into the Files To Add list. (Ctrl + click to select multiple files.)

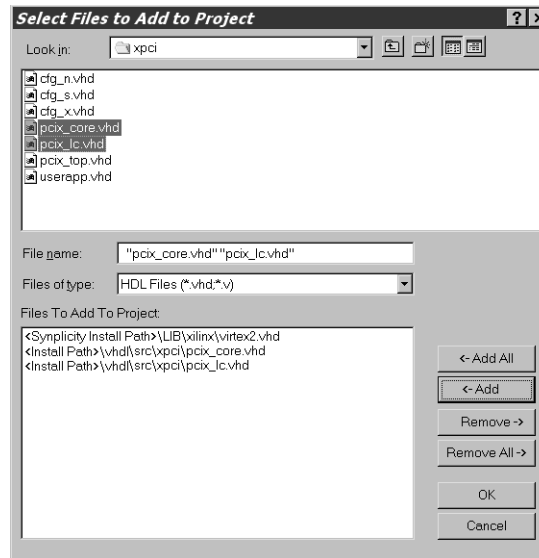

Figure 5-12: Files to Add (LogiCORE Files)

The final set of design files (the user application) is located in:

<Install Path>/vhdl/example/source

- Navigate to the source directory (Figure 5-13), select the cfg_test_s.vhd, pcix_top.vhd, and userapp.vhd, then click Add.

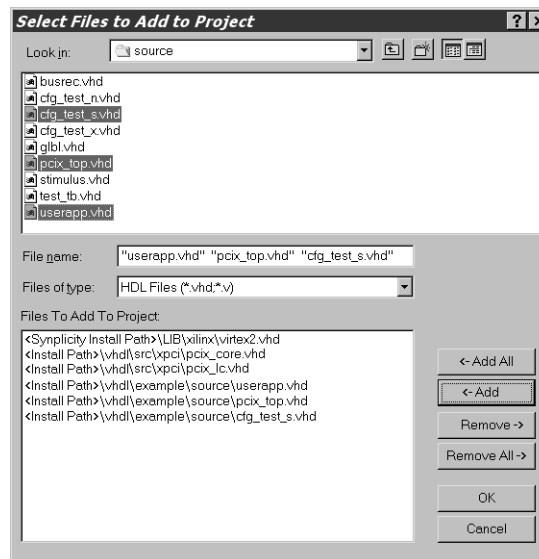

Figure 5-13: Files to Add (User Application)

8. In the Source Files list, view the list of newly added source files by double-clicking the flowtest/vhdl folder (if it is not already open). Drag to reorder the source files in the hierarchical order shown in [Figure 5-14](#).

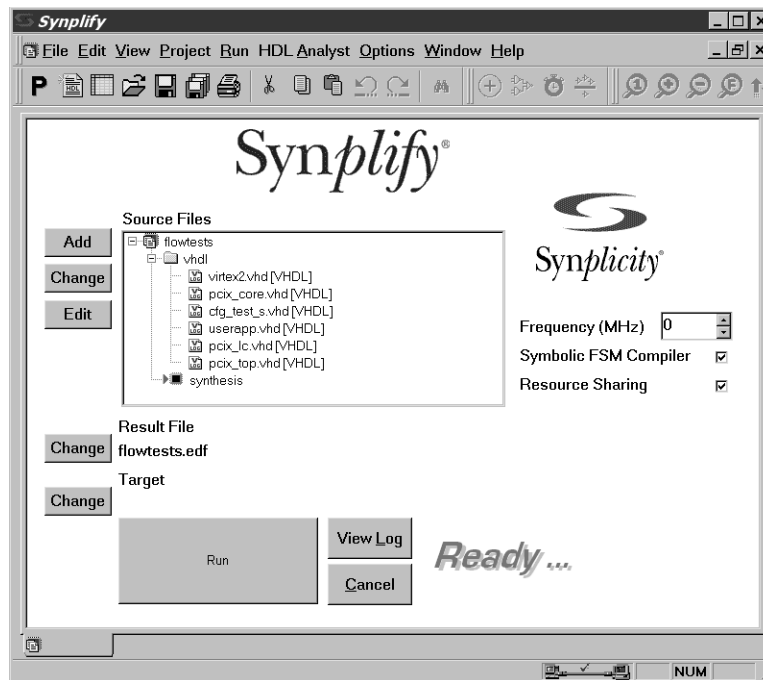

Figure 5-14: Main Project Window

9. Click Change Result File to display the EDIF Result File dialog box; then move the to following directory:
`<Install Path>/vhdl/example/synthesis`
10. Name the file **pcix_top.edf** and click OK to set the name of the result file and return to the main project window.

Note: In practice, the directory for the EDIF result file does not need to be changed. However, the sample processing scripts included with the example design assume that the output EDIF files will be located in the synthesis directory.

- From the main project window, click Change Target to display the Options for Implementation dialog box, as shown in Figure 5-15.

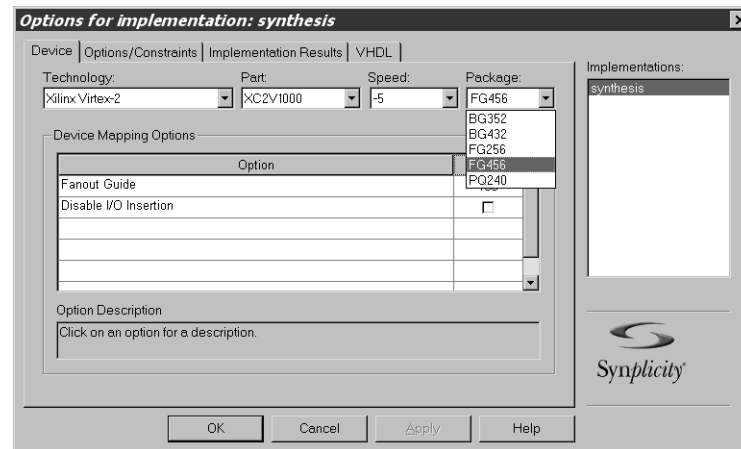

Figure 5-15: Options for Implementation: Device

- On the Device tab, set the Technology, Part, Speed, and Package options to reflect the targeted device (a 2V1000FG456-5 in this example). Be sure that Disable I/O Insertion is deselected.
- On the Options/Constraints tab, deselect Symbolic FSM Compiler (leave Resource Sharing selected) and set the Frequency to 66 MHz.
- On the Implementation Results tab, deselect Write Vendor Constraint File.
- Click OK to return to the main project window; then click Run.

Synplify synthesizes the design and writes out an optimized EDIF file. In the lower-right corner of the window, the various stages or synthesis, such as Compiling or Mapping, are displayed. When the process is complete, *Done* is displayed. Note that Synplify may issue a number of warnings (which are expected) about instantiated I/O cells and attributes used for other synthesis tools.

Exemplar LeonardoSpectrum

Before attempting to synthesize a design, ensure that the Exemplar LeonardoSpectrum environment is properly configured for use.

- Navigate to the synthesis directory:

```
cd <Install Path>/hdl/example/synthesis
```

The synthesis directory contains a script for use with LeonardoSpectrum.
- Edit the script to change the following line:

```
cd <Install Path>/hdl/example/synthesis
```

Modify the path to point to the actual installation location, and then save the file.
- Invoke LeonardoSpectrum.

Depending on the implementation, you may also need to change the wrapper file and the simulation model, but this is not required for the example design.
- Synthesize the design by running the `leonardo_s.tcl` script.

Note: if you run LeonardoSpectrum with the graphical user interface, the quick setup form cannot be used to synthesize the design. Instead, choose File > Run Script from the menu.

The end result of the synthesis step is an EDIF file that is fed into the Xilinx implementation tools during the implementation step.

In practice, the provided script file must be modified to accommodate other designs. To provide insight into the synthesis script, the major steps are presented below:

1. Various synthesis options are set through the use of environment variables. These must be present in the script, and should not be modified. The synthesis library is also loaded; this may be altered for different devices and speed grades.
2. The design is loaded by reading in the design files. At this point, the top level module is declared as the `present_design`. The script adds `nopad` attributes (with a value of `FALSE`) to all PCI-X bus interface signals. The I/O structures for these ports are directly instantiated in the wrapper file.
3. The optimization step is done with the `-hierarchy preserve` and the `-chip` options. The `-hierarchy preserve` option prevents LeonardoSpectrum from dissolving the design hierarchy. The `-chip` option indicates that automatic I/O buffer insertion should be performed.
4. After synthesis is complete, the synthesized netlist is written out.
5. The tool may issue warnings about unused signals. These warnings are expected.

Xilinx XST

Before attempting to synthesize a design, ensure that the Xilinx XST environment is properly configured. Synthesis is supported only from the XST command line.

1. Navigate to the synthesis directory:

```
cd <Install Path>/hdl/example/synthesis
```

The synthesis directory contains a script for use with Xilinx XST; this script is called `run_xst.bat` for PC platforms and `run_xst.sh` for Unix platforms. Note that the `run_xst.cmd` and `run_xst.prj` files are common and used by both scripts.

2. If required, modify the files as required to suit your application. You may need to change the target architecture and select different wrapper and configuration files.
3. Synthesize the design by running the script.

The end result of the synthesis step is an NGC file, which is fed into the Xilinx implementation tools during the implementation step. The tool may issue warnings about unused signals; these warnings are expected.

Implementing a Design

This chapter describes the use of supported FPGA implementation tools using the *Userapp* example design. If you are using a design with reference clocks, substitute *pcix_top* with *pcix_top_r* and *test_tb* with *test_tb_r*.

Supported FPGA implementation tools are included with the ISE Foundation v11.1 software.

ISE Foundation

Before implementing a design, ensure that the Xilinx environment is properly configured and that the design has been successfully synthesized.

1. Navigate to the implementation directory:

```
cd <Install Path>/hdl/example/xilinx
```

This directory contains the `run_xil_n`, `run_xil_s`, and `run_xil_x` scripts. These call the appropriate tools to place and route the example design in one of three possible incarnations: PCI only, Dual Mode, and PCI-X only. Use the script that corresponds to the core configuration you have selected. For the default example design, the Dual Mode script should be used.

2. Inspect the appropriate script file and note the following:
 - ◆ The `ngdbuild` command lists both `../src/xpci` and `../synthesis` as search directories. The `xpci` directory contains a netlist of the core interface, and the `synthesis` directory must contain the EDIF netlist generated during design synthesis.
 - ◆ The `ngdbuild` command also reads a user constraints file that corresponds to a desired target device and a particular version of the core interface.
 - ◆ To target a different device or to use a different version of the core interface, the constraints file must be changed to match the device and interface selection. The available selections are listed in the [Chapter 3, "Family Specific Considerations."](#)
 - ◆ The user constraints files provided with the core interface contain constraints that guarantee pinout and timing specifications. These constraints must be used during processing.
 - ◆ Any additional constraints that pertain to the user application must be placed in this file. Before making additions to the user constraints file, back up the original so that it may be restored if necessary.
 - ◆ The `map` command requires no special arguments, but uses an input/output register packing option.
 - ◆ The PAR effort levels and delay cleanup iterations may be adjusted if necessary.

- ◆ The `trce` command performs a static timing analysis based on the design constraints originally specified in the user constraints file.
 - ◆ The `netgen` command generates a simulation model of the placed and routed design.
3. Implement the design by running the appropriate script.

During initial processing trials, it is useful to enter the commands one at a time from the command line, instead of running the script, so that you may inspect the output of each step.

Timing Simulation

This chapter describes the use of supported timing simulation tools using the *Userapp* example design. If you are using a design with reference clocks, substitute *pcix_top* with *pcix_top_r* and *test_tb* with *test_tb_r*.

Note: The stimulus source file delivered with the example design (*source/stimulus.hdl*) simulates in both PCI and PCI-X mode, automatically detecting the proper mode and bus speed based on power-on signaling.

Cadence IUS

Before attempting timing simulation, ensure that the IUS environment is properly configured for use.

1. Navigate to the timing simulation directory and copy the back annotated timing models from the implementation directory:

```
cd <Install Path>/verilog/example/post_sim
cp ../xilinx/*.v ./
cp ../xilinx/*.sdf ./
```

2. Edit the *test_tb.f* file. This file lists command line arguments for IUS, and is shown below:

```
../source/stimulus.v
../source/test_tb.v
../source/busrec.v
./pcix_top_s_routed.v
+libext+.vmd+.v
-y <Xilinx Install Path>/verilog/src/simprims
```

Modify the library search path by changing *<Xilinx Install Path>* to match the Xilinx installation directory. Save the file.

3. To run the IUS simulation, type the following:

```
ncverilog -f test_tb.f
```

IUS processes the simulation files and exits. The test bench prints status messages to the console. After the simulation completes, view the *ncverilog.log* file to check for errors.

The SimVision browser may be used to view simulation results. SimVision is started with the following command:

```
simvision
```

Mentor Graphics ModelSim

Before attempting functional simulation, ensure that the ModelSim environment is properly configured for use.

Verilog

1. Navigate to the timing simulation directory and copy the back annotated timing models from the implementation directory:

```
cd <Install Path>/verilog/example/post_sim
cp ../xilinx/*.v ./
cp ../xilinx/*.sdf ./
```

2. Edit the `test_tb.f` file. This file lists command line arguments for ModelSim, and is shown below:

```
../source/stimulus.v
../source/test_tb.v
../source/busrec.v
./pcix_top_s_routed.v
+libext+.vmd+.v
-y <Xilinx Install Path>/verilog/src/simprims
```

Modify the library search path by changing `<Xilinx Install Path>` to match the Xilinx installation directory. Save the file.

3. Invoke ModelSim, and ensure that the current directory is set to:

```
<Install Path>/verilog/example/post_sim
```

4. To run the simulation:

```
do modelsim.do
```

This compiles all modules, loads them into the simulator, displays the waveform viewer, and runs the simulation.

VHDL

1. Navigate to the timing simulation directory and copy the back annotated timing models from the implementation directory:

```
cd <Install Path>/vhdl/example/post_sim
cp ../xilinx/*.vhd ./
cp ../xilinx/*.sdf ./
```

2. View the `test.files` file. This file lists the individual source files required, and is shown below:

```
./pcix_top_s_routed.vhd
../source/busrec.vhd
../source/stimulus.vhd
../source/test_tb.vhd
```

3. Invoke ModelSim, and ensure that the current directory is set to:

```
<Install Path>/vhdl/example/post_sim
```

4. Create the SimPrim and UniSim libraries. This step only needs to be done once, the first time you perform a simulation:

```
vlib simprim
vcom -93 -work simprim <Xilinx Install
Path>/vhdl/src/simprims/simprim_Vpackage_mti.vhd
vcom -93 -work simprim <Xilinx Install
Path>/vhdl/src/simprims/simprim_Vcomponents_mti.vhd
vcom -93 -work simprim <Xilinx Install
Path>/vhdl/src/simprims/simprim_VITAL_mti.vhd
vlib unisim
vcom -93 -work unisim <Xilinx Install
Path>/vhdl/src/unisims/unisim_VPKG.vhd
vcom -93 -work unisim <Xilinx Install
Path>/vhdl/src/unisims/unisim_VCOMP.vhd
vcom -93 -work unisim <Xilinx Install
Path>/vhdl/src/unisims/unisim_VITAL.vhd
```

5. To run the simulation:

```
do modelsim.do
```

This compiles all modules, loads them into the simulator, displays the waveform viewer, and runs the simulation.